

## 89181203-SF

### 12V Dual Fan Condenser

- Stainless Steel finish
- Multiple finish options  
Black (89181203)/White (89181203-1)



Part of the...  
**SNOWBIRD SERIES**  
...of products

## 89181203-SF SPECIFICATIONS

**CAPACITY:** Cooling 29,719 BTUH (8.7 kW)

**WEIGHT:** 16.5 lbs (7.5 kg)

**AIR FLOW:** 1353 CFM (38.31 CMM)

**CURRENT DRAW:** 16.6 Amp Draw

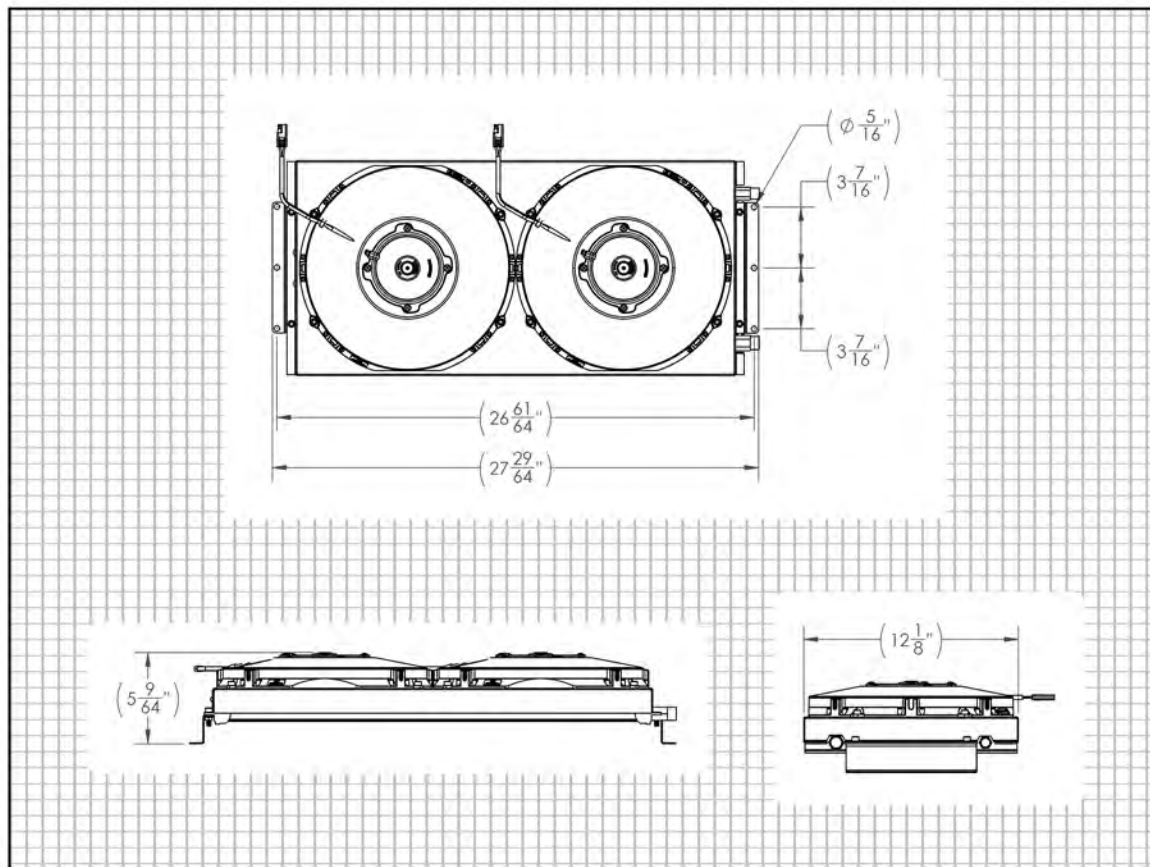

### PRODUCT DIMENSIONS

**Width:**  
27.45 in  
[697.2 mm]

**Height:**  
5.14 in  
[130.8 mm]

**Depth:**  
12.13 in  
[308.1 mm]

SCAN FOR MORE INFORMATION

